

Article number: 0120062

Description: Retaining ring AL 45X1,75
Spring steel

Measures

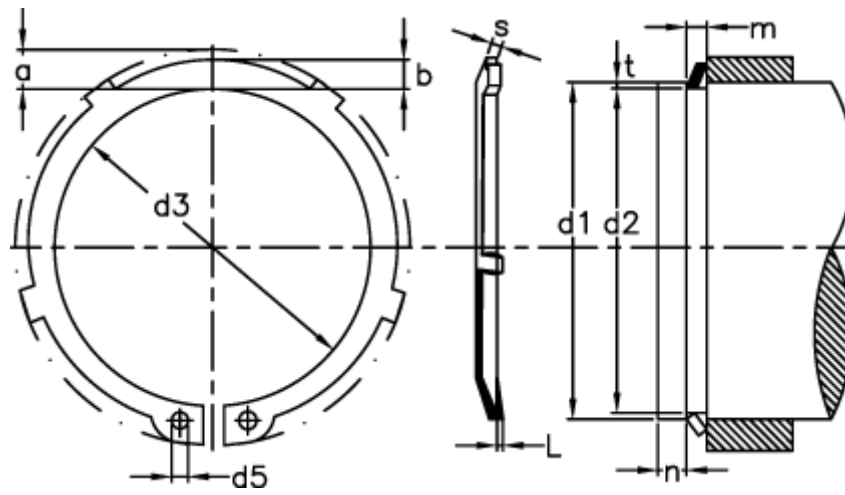

a max	= 7.2	FL max kN	= 0.92	s	= 1.75
b	= 4.6	FN kN	= 28.60	tol	= -0.25
C kN/mm	= 1.86	FRg kN	= 9.35	tol	= +0,39 -0,90
d1	= 45	FR kN	= 49.0	u	= 0.10
d2	= 42.5	g	= 2.0		
d3	= 41.5	L min	= 0.60		
d5 min	= 2.5	m min	= 1.85		
Description	= AL 45	Nominal drive	= 3.8		